

**CEASE
FIRE**

**BECAUSE KITCHEN FIRES ARE
TOO HOT TO HANDLE**

IMAGIX Studio
Imagix Studio & Projects Private Limited

DOMESTIC KITCHEN
FIRE SUPPRESSION
SYSTEM (WATERMIST/
WET CHEMICAL-BASED)

TESTED BY **bsi.**

IN CASE OF FIRE
PULL OUT PIN AND
HIT THE KNOB.

**CEASE
FIRE**



**Ceasefire Domestic Kitchen
Fire Suppression Range**

CONTENTS

Kitchen Firefighting Systems for Homes

Introduction

05

Enviro Series

Watermist Technology

08

System at a glance

09

System Variants

10

Key Components of the System

11

Features

12

Application Areas

13

Ultra Series

System at a glance

15

System Variants

16

Key Components of the System

17

Features

18

Application Areas

19

HOME- YOUR SAFE PLACE ON EARTH

Your Dream home - a warm abode, carefully curated, tastefully done. It's a perfect place for your loved ones to retreat. It's a gateway to your life a reflection of who you are!

So much for the leisure & comfort of your family, but did you ever spare a second, thinking about the safety of your loved ones? Home should be the safest place that one can make.



WHAT IS THE SAFETY QUOTIENT OF YOUR HOME?

Fire is a real threat and it can happen to anyone, anytime. Make sure you equip your house to fight fire even when you are not around.

Every premises has some vulnerable spaces that are prone to fire. The idea of a perfect fire safety plan entails safeguarding those spaces within the premises so as to achieve overall fire safety.

KITCHEN FIRES- A TICKING BOMB

One of the best ways to control fire is to catch it young and by safeguarding the potential fire threats. Kitchen fire is one of the major initiators of fire in our household. Most of the fire accidents start in the kitchen, making it one of the single biggest sources of fire in Indian homes.

Kitchen fire is extremely volatile so it spreads rapidly and has a very high tendency to cause a complete burn-down, leaving little or no room to escape.

The best way to stop the spread such fire is early detection and efficient firefighting.



CHALLENGES FACED TO EXTINGUISH IT

Fires in Kitchens are often oil based and greasy. Such fires are extremely volatile and difficult to control and can spread at an exponential rate.

Inadequate or improper firefighting can make the kitchen fire situation turn extremely dangerous. Attempting to douse kitchen fires with water, on the other hand, may turn fatal as it makes the oil splash and aids in the spreading of fire.

INTRODUCING THE CEASEFIRE DOMESTIC KITCHEN FIREFIGHTING RANGE

The need of the hour is an automatic suppression system which detects & extinguishes fire, all by itself without any human interface. A solution that is ideal for modern homes especially when cooking today entails extensive deep, shallow & stir frying, baking, roasting, steaming and pressure cooking.

Ceasefire a leader in fire safety and a pioneer in commercial kitchen fire suppression system has adapted its revolutionary commercial kitchen fire-fighting technology to suits the needs of the modern Indian homes.



The next level of fire safety for domestic kitchens conforms to bsi.

Ceasefire presents a next generation fire safety technology in the form of a Domestic Kitchen Fire Suppression system for the very first time in India.

The company's extensive experience in the domain of commercial kitchen fire safety enables Ceasefire to introduce this range.

The range comes in two versatile variants of:

- | Watermist Based Systems (Enviro Series)
- | Wet Chemical Based Systems (Ultra Series)

THE UNDERLYING APPROACH TO KITCHEN FIRE SUPPRESSION



A.

Early Detection:

Best way to fight fire is when it is still in its nascent stage. During this time the fire is easy to tackle and the collateral damage is minimal. Therefore it is crucial to employ best fire detection techniques which can catch early signs of fire.

The Ceasefire domestic hood fire suppression system's detection is based on the highly advanced pneumatic heat sensing tube which has proven record of effective fire detection at early stages.

B.

Efficient Firefighting:

Once ignited the fire must be killed effectively using specialised extinguishing agent designed exclusively for kitchen fires.

The Ceasefire systems use specially designed nozzles that aid effective fire fighting by optimally dispersing the extinguishing agent and is good for quelling fires arising out of any type of cooking.

The agent dispersing nozzles are strategically located across the length of the hood. This ensures that the extinguishing agent covers the entire hood area leaving no blind spots in fire fighting.





hindware
KITCHEN ENVIRO

DOMESTIC KITCHEN
FIRE SUPPRESSION
SYSTEM (WATERMIST/
WET CHEMICAL-BASED)

TESTED BY **bsi.**

WATERMIST BASED DOMESTIC KITCHEN FIREFIGHTING RANGE - ENVIRO SERIES

Tested By: **bsi.**

HARNESSING THE POWER OF WATER, AND MULTIPLYING IT.

It's common knowledge that there is no extinguishing agent more potent than water. With its massive cooling power of 2.6 MW per liter per second, water kills even the largest of fires in minutes. But even fire's worst adversary has its shortcomings. Using water on oil fires or an electrically started blaze can be a fatal mistake. What you need is cutting-edge technology that changes water's natural form, so that it can fight kitchen fires without causing any collateral damage.

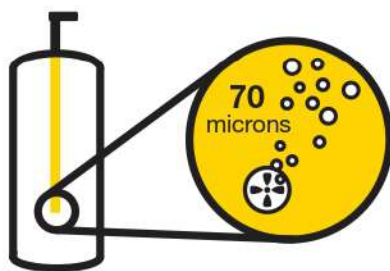
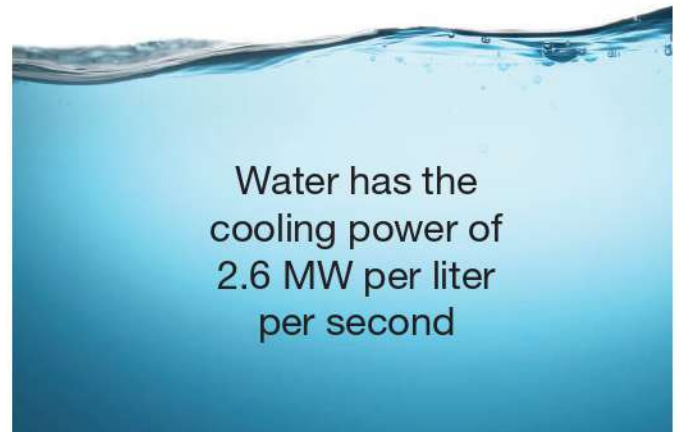

First, the Multi-Rotors located within the **system turn water into droplets of 70 micron** size by mixing it with air in a pre-set proportion.



This makes it the only system of its kind that combines two revolutionary technologies – Watermist and stored pressure – into an extinguisher that **can take down even the largest of fires, including oil and electrically started fires.**

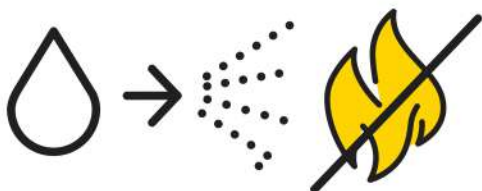

This produces Watermist, which increases the coverage area of water to fight fires many times over. The stored pressure technology is used to deliver Watermist with a kinetic force strong enough to overcome the fire's own convection currents.

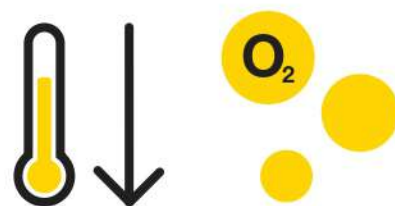

When Watermist falls on there, it rapidly brings down the temperature to below combustible levels, cuts off the oxygen supply and kills the flames.

THE SYSTEM AT A GLANCE

Ceasefire's domestic kitchen fire suppression system takes care of the aesthetics of your painstakingly curated home.

The detection device, activation nozzles and the agent cylinders are all carefully tucked inside so that the components of the system blends in the current scheme of things in the area of application, without clashing with the décor of the kitchen.

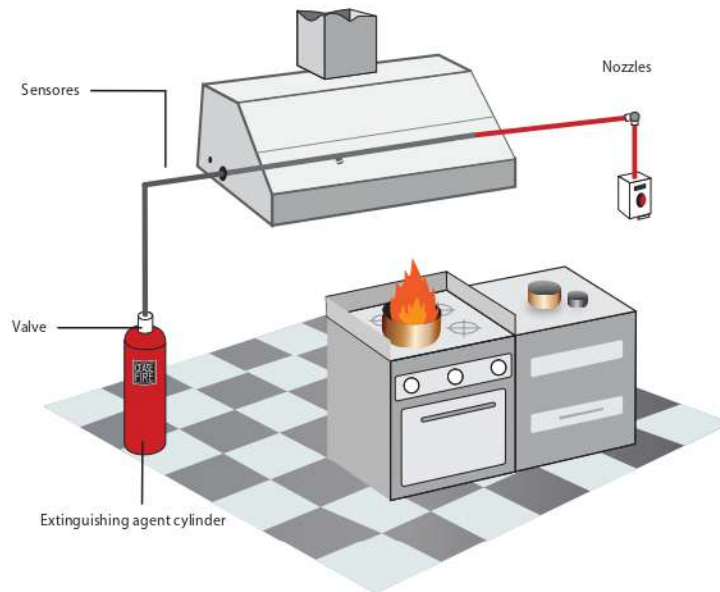

Ceasefire domestic kitchen firefighting range operates automatically in the event of fire. This removes the risk of a person to fight the fire or even worse fight fire incorrectly.

The system detects fire through its pneumatic heat sensing tube spread through the length of the hood. The tube helps in automatic detection and activation of the suppression system.

On coming in contact with fire the HST ruptures at a pre-determined temperature, creating a pressure differential in the system valves, activating the system.

Watermist is used as an extinguishing agent. Being a clean and green extinguishing agent there is minimal post

fire damage and the kitchen can be wiped clean. Watermist does not cause any damage; either to the expensive kitchen equipment or food items

The extinguishing agent is discharged out of the specialized nozzles ensuring effective & efficient firefighting.

The system is adept in handling all kinds of kitchen fires like fires arising due to deep frying, shallow frying, baking, grilling or roasting et al.

On coming with contact with fire the watermist converts into steam. Steam blocks the oxygen supply and brings the temperature to below combustion levels thereby, extinguishing the fire.

VARIANTS AVAILABLE

The Watermist Based Domestic Kitchen Fire Suppression System (Enviro Series) comes in two variants.

1. The 3 Litre Two Nozzle Variant

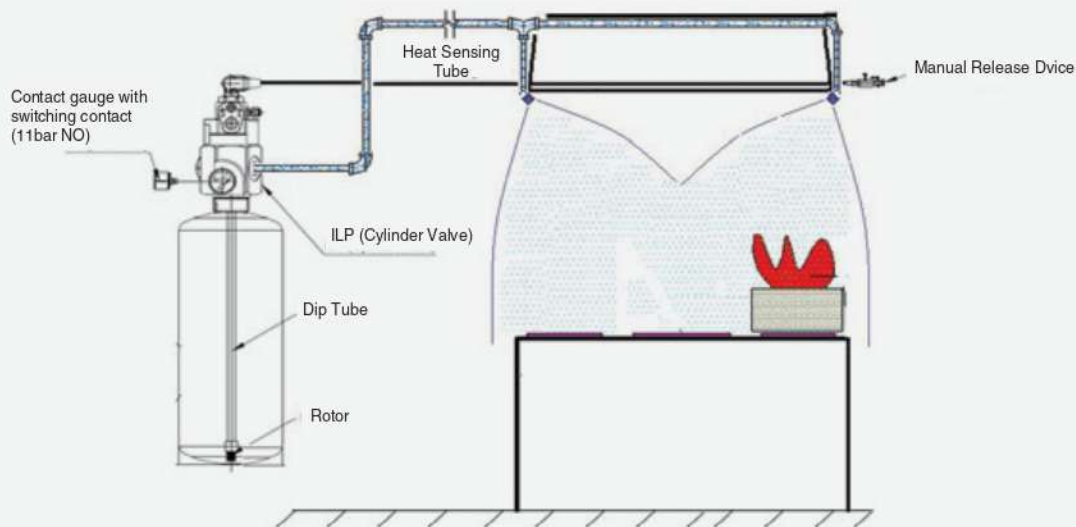

2. The 4.5 Litre Three Nozzle Variant

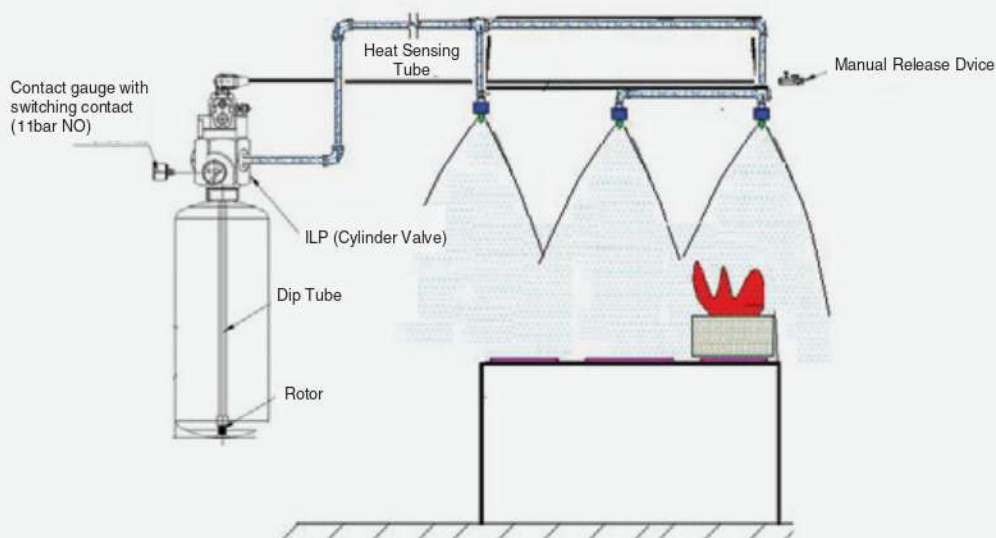

The system is covered with a 12 months warranty, given that periodical maintenance is done by the authorized Ceasefire representative.

KEY COMPONENTS OF THE SYSTEM

Supply unit

It is based on rotor units placed inside cylinders filled with filtered water and gas (air or nitrogen). The rotors are designed to produce a medium pulse flow of extinguishing agent and the propellant.

Cylinder valve

The valve is the most crucial component of the suppression system. In case of fire the valve the pressure in HST drops, opening the valve outlet. This in turn expels the extinguishing agent through a separate discharge line.

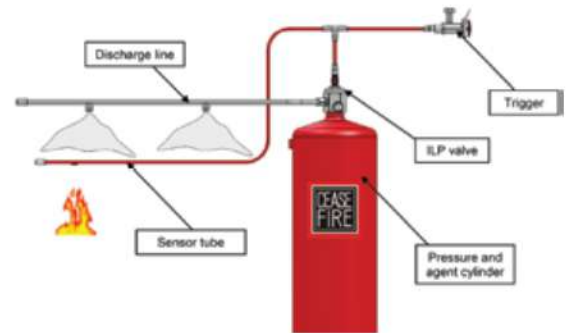

Heat sensing tube

The system's detection is based on pneumatic heat sensing tube. The tube is made of high grade polymer plastic. When the tube comes in contact with fire, it bursts open (does not melt) at a pre-determined rate, actuating the system.

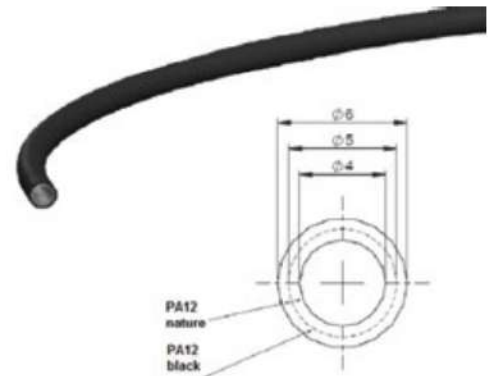

Manual actuator

Manual actuator is a manual trigger to activate the system. It is installed in or at the end of the detection line. If actuated, it manually simulates and bursts the heat sensing tube. To actuate the manual trigger simply pull the safety pin and press the red strike knob!

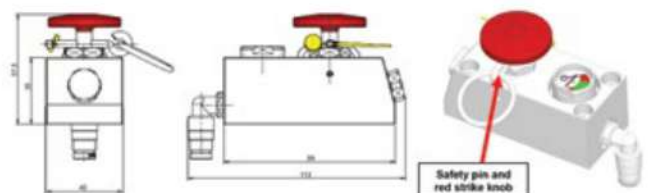

Extinguishing nozzles

Ceasefire uses CSFH (Circle Single Fluid Head) for extinguishing. The nozzles have special cap which protects the nozzles from grease and dust.



CEASEFIRE'S DOMESTIC WATERMIST KITCHEN SUPPRESSION SYSTEM GIVES YOU MORE

- | Quick and easy installation
- | Extinguishing system designed exclusively for kitchen fires at home
- | No collateral damage thanks to Watermist
- | Works on class A, B, C, F fires and fires involving electrically charged devices
- | Maximum extinguishing efficiency, as the Watermist is dispersed over a large surface
- | Minimal maintenance
- | Easy clean up after activation

FEATURES



24-hour cook-top fire guard - Automatic detection and actuation controls ensure fire protection



Automatic fire suppression- requires no human activation



Multiple Triggers - The system can be triggered either by the manual actuation system or the automatic detection system.



Highly Effective - Watermist prevents re-ignition by cooling down the temperature of the heated oil.



No Collateral Damage - Watermist being a clean agent does not cause any harm to kitchen or equipments.



Unobtrusive Design - The system components camouflages into the current design of kitchen



Highly Reliable - Adapted from Ceasefire's LPCB certified commercial kitchen suppression systems.



APPLICATION AREAS



**Apartments and High
Rise Dwellings**

**Villas & Independent
Houses**



DOMESTIC KITCHEN
FIRE SUPPRESSION
SYSTEM (WATERMIST/
WET CHEMICAL-BASED)

TESTED BY **bsi.**



**WET CHEMICAL BASED
DOMESTIC KITCHEN FIRE
FIGHTING RANGE-
THE ULTRA SERIES**

Tested By: **bsi.**

THE SYSTEM AT A GLANCE

The Wet Chemical Kitchen Suppression System- Ultra Series incorporates both manual and automatic protection by a pneumatic detection and actuation technique.

The chimney is covered with the pneumatic Heat Sensing Tube (HST). On coming with contact with fire, HST burst open at a pre-determined temperature.

This leads to a drop of pressure which signals the indirect valve thereby activating the system. The strategically placed nozzles disperse the extinguishing agent evenly over the entire cook top area ensuring no blind spots during fire fighting.



HOW THE AGENT WORKS

Wet Chemical is a chemical foaming agent that is ideal to fight Class A, B and fires arising in the kitchen. The foam is an environment friendly agent. It is 99% biodegradable (up to 72% within three days).

The wet chemical has a blanketing effect on the flames which cool the super heated oil to below its self-ignition point. Unlike the Class B fires (where the ignition point of fuels is low) cooking oils burn up at extremely high temperatures to the tune of 350°C-380°C.

Wet Chemical is an ideal agent to address the peculiar challenges in kitchen fire fighting. Being a de-greasing substance, the extinguishing agent also doubles up as a cleaning agent for kitchen.

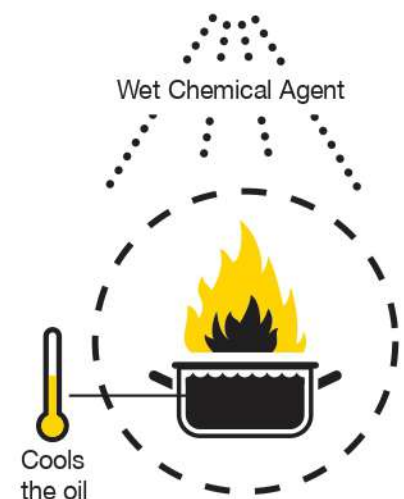

VARIANTS AVAILABLE

The Domestic Kitchen Fire Fighting Range -Ultra Series comes in 2 variants.

1. 1 Litre variant with 1 Nozzle

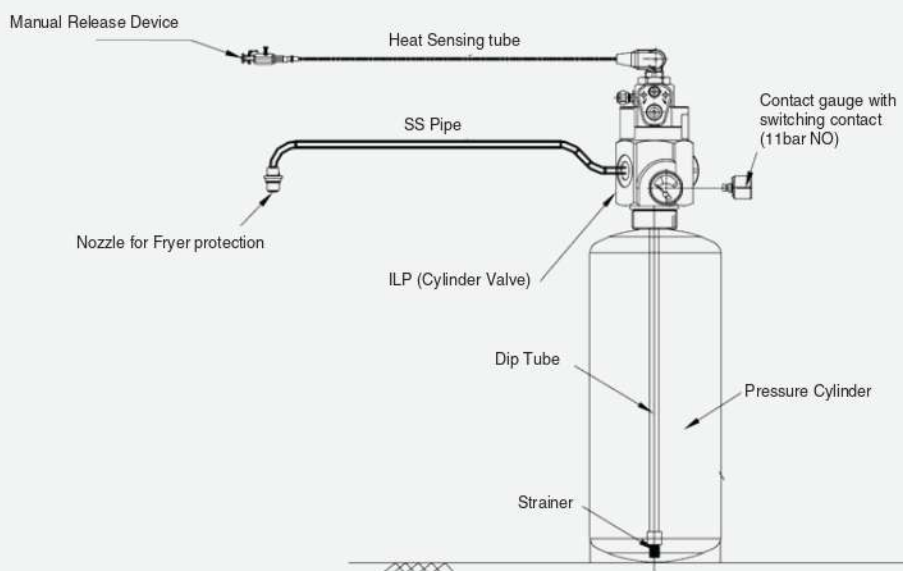

2. 1 Litre Variant with 2 Nozzles

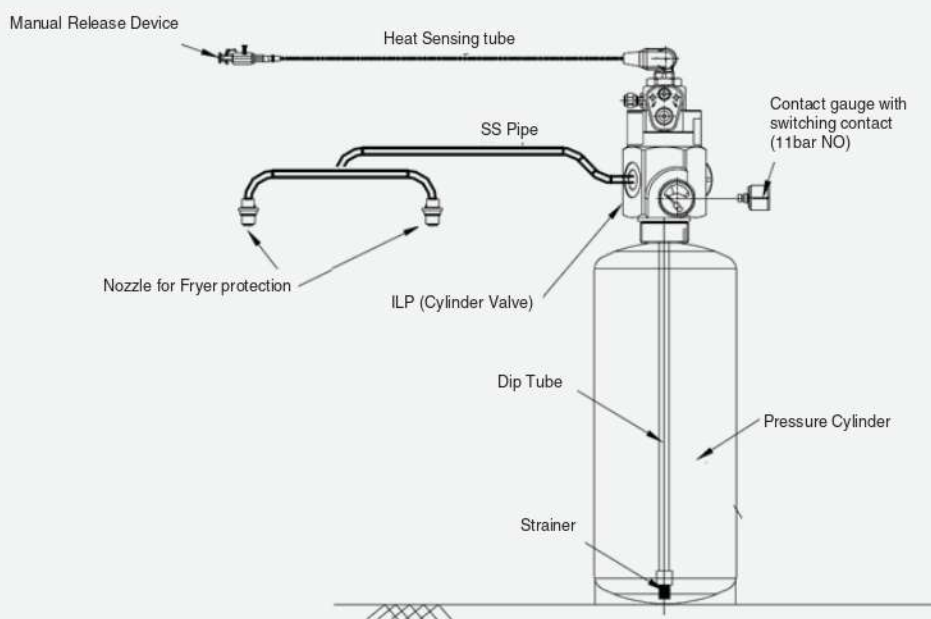

The system is covered with a 12 months warranty, given that periodical maintenance is done by the authorized Ceasefire representative.

KEY COMPONENTS OF THE SYSTEM

Supply unit

It is based on rotor units placed inside cylinders filled with wet chemical and gas (air or nitrogen). The rotors are designed to produce a medium pulse flow of extinguishing agent and the propellant.

Cylinder valve

The Cylinder valve is a key component of the system that corresponds between the detection line (HST) and the agent discharge line. The valve activates the system the moment pressure drops in the detection line.

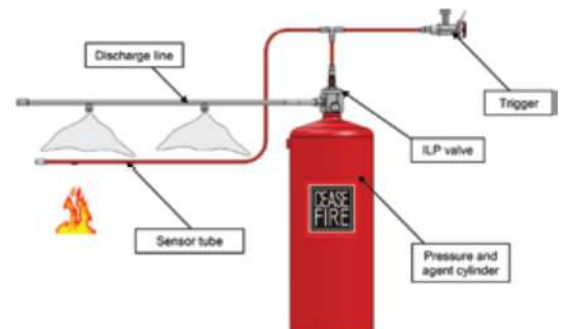

Heat sensing tube

The system's detection is based on pneumatic heat sensing tube. The tube is made of high grade polymer plastic. When the tube comes in contact with fire, it bursts open (does not melt) at a pre-determined rate, actuating the system.

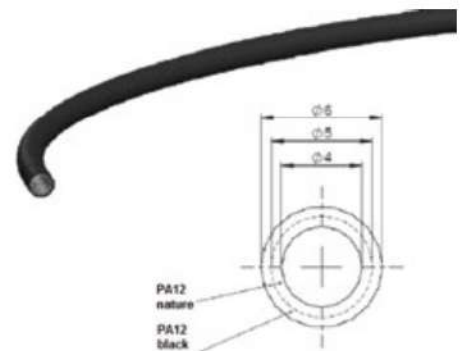

Manual actuator

Manual actuator is a manual trigger to activate the system. It is installed in or at the end of the detection line. If actuated, it manually simulates and bursts the heat sensing tube. To actuate the manual trigger simply pull the safety pin and press the red strike knob!

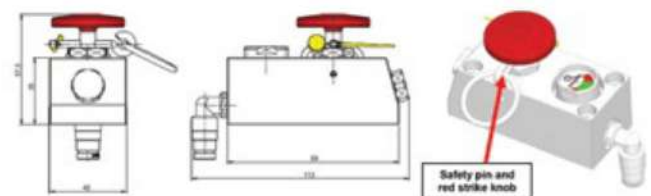

Extinguishing nozzles

The nozzles are specially designed and strategically placed across the chimney so that the extinguishing agent is dispersed efficiently across cook top. This ensure there are no blind spots in fire fighting.

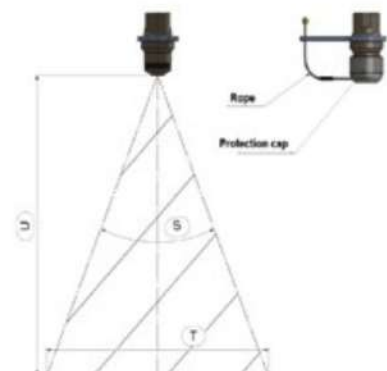

CEASEFIRE'S DOMESTIC WETCHEMICAL KITCHEN SUPPRESSION SYSTEM GIVES YOU MORE

- | Quick and easy installation
- | Extinguishing system designed exclusively for kitchen fires at home
- | Post usage, the extinguishing agent doubles up as a cleaning agent
- | Works on class A, B, C, F fires and fires involving electrically charged devices
- | Minimal maintenance
- | Environmental friendly; does not produce hazardous by-products

FEATURES



24-hour cook-top fire guard - Automatic detection and actuation controls ensure fire protection is always 'up'.



Multiple Triggers - The system can be triggered either by the manual actuation system or the automatic detection system.



Highly Effective - Wet chemical agent prevents re-ignition by cooling down the temperature of the heated oil.



No Collateral Damage - Extinguishing agent doubles up as a cleaning agent after use



Unobtrusive Design - The system components camouflages into the current design of kitchen



Highly Reliable - Adapted from Ceasefire's LPCB certified commercial kitchen suppression systems.



Automatic fire suppression- requires no human activation



APPLICATION AREAS



**Apartments and High
Rise Dwellings**

**Villas & Independent
Houses**





Flat No: 302- 303 03 rd Floor, Hira Niketan, Kaliket Nagar,
Back Side Of Vatika Premier Hotel, IOCL Pipe Line Project HO
Building, Bailey Road, Danapur- Patna. Pin: 801503, Bihar
+91 9431011006, 9431076164, 9431099823, 9431133484

Base Line: 0612 3553356

Email: imagixprojects@gmail.com

www.imagixprojects.com

Download the Ceasefire app.



Ceasefire Industries Private Limited,
Plot No. 4, Second Floor, Sector - 135,
Noida - Greater Noida Expressway,
Noida - 201 301, Uttar Pradesh (India)
t +0120-4665800

Call our Free Hotline :
1800 120 3473 / +91 9540 666 666
or call +91 120 4223473

www.ceasefire.in

Follow us on:

